

Eden

IT

Sedute comode e accoglienti, perfette per l'attesa e la riunione

EN

Comfortable and welcoming seats, perfect for the waiting area and the meeting.

FR

Sièges confortables et accueillants, parfaits pour l'attente et la réunion.

ES

Asientos cómodos y acogedores, perfectos para la espera y la reunión.

Eden/

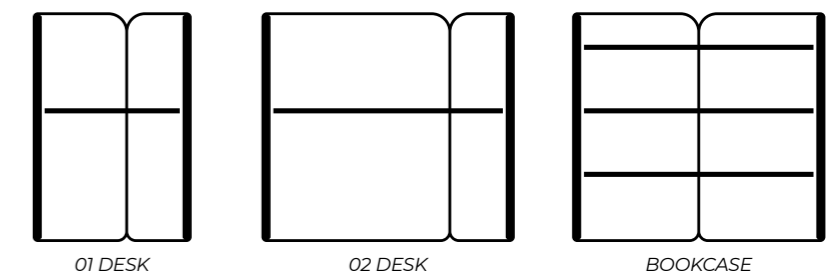
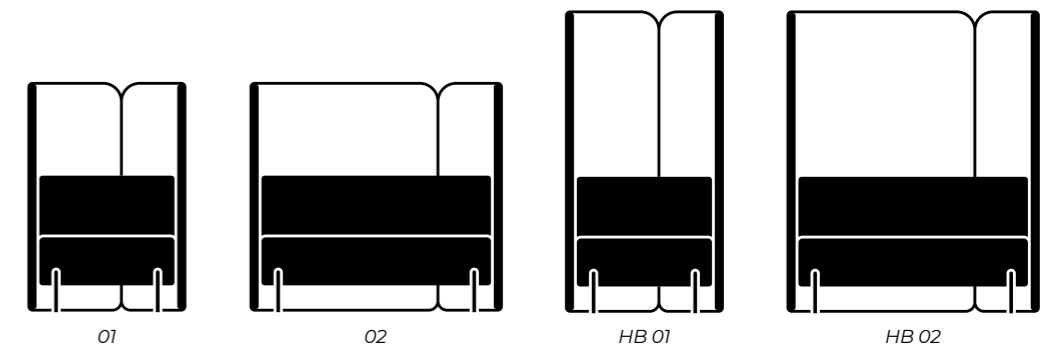

Eden

design by Paolo Pampanoni

archiproducts
 DESIGN AWARDS
 WINNER 2021

IT

Una famiglia completa di divani, poltrone e schermi acustici che vivono autonomamente o in raffinate e performanti configurazioni, ideali per allestire spazi innovativi e funzionali. L'attesa, la conversazione, la riunione, il lavoro individuale e lo studio vivono in un prodotto semplice e articolato.

EN

A complete family of sofas, armchairs, and acoustic screens that live independently or in refined and performing configurations, ideal for setting up innovative spaces. The waiting, the conversation, the meeting, the individual work, and the study live in a simple and articulated product.

FR

Une famille complète de canapés, fauteuils et écrans acoustiques qui vivent de manière autonome ou dans des configurations raffinées et performantes, idéales pour aménager des espaces innovants et fonctionnels. L'attente, la conversation, la réunion, le travail individuel et l'étude vivent dans un produit simple et articulé.

ES

Una familia completa de sofás, sillones y pantallas acústicas que funcionan de forma independiente o en configuraciones refinadas y de alto rendimiento, ideales para crear espacios innovadores y funcionales. La espera, la conversación, la reunión, el trabajo individual y el estudio conviven en un producto simple y articulado.





EDEN 01/EDEN 02



IT

La gamba in acciaio a vista diventa un segno identificativo dell'intera collezione. Un deciso elemento strutturale esterno che segue la morbidezza delle parti imbottite con un perfetto abbinamento di forme. Un particolare curato nel design e nella tecnica costruttiva.

EN

The exposed steel leg becomes an identifying hallmark of the entire collection. A decisive external structural element that follows the softness of the padded parts with a perfect combination of forms. A particular taken care of in the design and in the technical construction.

FR

Le pied en acier visible devient une marque d'identification de l'ensemble de la collection. Un élément structurel externe décisif qui suit la douceur des parties rembourrées avec une parfaite combinaison de formes. Une attention particulière à la conception et à la technique de construction.

ES

La pata de acero a la vista se convierte en un signo identificativo de toda la colección. Un osado elemento estructural externo que continúa la suavidad de las partes acolchadas con una asociación perfecta de formas. Un cuidado particular en el diseño y la técnica constructiva.





IT

Un angolo caratterizzato da un grande comfort acustico, dedicato al lavoro individuale, a casa o in ufficio. Una piccola postazione riservata e funzionale in cui le forme avvolgenti dei pannelli in tessuto si integrano perfettamente con il piano di lavoro e la mensola in legno.

EN

A corner characterised by great acoustic comfort, dedicated to individual work, at home or in the office. A small private and functional workstation in which the enveloping forms of the fabric panels will integrate perfectly with the wooden worktop and shelf.

FR

Un coin caractérisé par un grand confort acoustique, dédié au travail individuel, à la maison ou au bureau. Un petit endroit réservé et fonctionnel où les formes enveloppantes des panneaux en tissu s'intègrent parfaitement au plan de travail et à l'étagère en bois.

ES

Un rincón caracterizado por un gran confort acústico, dedicado al trabajo individual, en casa o en la oficina. Un pequeño puesto reservado y funcional, donde las formas envolventes de los tableros de tela se integran perfectamente con el tablero de trabajo y el estante de madera.



IT

Una postazione di lavoro completa, uno spazio chiuso in cui libreria e scrivania sono contenuti da diaframmi acustici che uniscono e separano ogni utilizzatore. La conversazione è riservata, il disturbo è schermato pur rimanendo all'interno di uno spazio operativo e affollato.

EN

A complete work station, an enclosed space in which bookcase and desk are contained by acoustic diaphragms that unite and separate everyone that uses it.

The conversation is private, the disturbance is shielded, while one remains within an operative and crowded space.

FR

Un poste de travail complet, un espace clos dans lequel la bibliothèque et le bureau sont contenus par des écrans acoustiques qui unissent et séparent tous ceux qui les utilisent. La conversation est confidentielle, la perturbation est blindée tout en restant dans un espace opérationnel et encombré.

ES

Un puesto de trabajo completo, un espacio cerrado donde la biblioteca y el escritorio están contenidos por diafragmas acústicos que unen y separan a quienes los utilizan. La conversación es reservada, el ruido está apantallado incluso dentro de un espacio de trabajo atestado de personas.



EDEN STUDIO

IT

Il sistema di aggancio rapido dei pannelli fonoassorbenti, l'innesto a slitta del piano di lavoro e i reggi mensola nascosti, permettono un rapido smontaggio e rimontaggio del box, garantendo una perfetta risposta alle esigenze di flessibilità operativa e variabilità del layout.

EN

The quick coupling system of the sound-absorbing panels, the slide coupling of the worktop, and the hidden shelf supports allow a rapid disassembly and reassembly of the box, ensuring a perfect response to the needs of operational flexibility and layout variability.

FR

Le système d'accouplement rapide des panneaux insonorisants, l'accouplement à glissière du plan de travail et les supports d'étagères cachés permettent un démontage et un remontage rapides du box, assurant une réponse parfaite aux besoins de flexibilité opérationnelle et de variabilité d'agencement.

ES

El sistema de ensamblaje rápido de las pantallas acústicas, el acoplamiento con corredera del tablero de trabajo y los soportes ocultos de los estantes permiten desmontar y volver a montar rápidamente el box, lo que garantiza una respuesta perfecta a las exigencias de funcionamiento flexible y disposición variable.



EDEN MEETING

IT

Il colloquio di lavoro o il brainstorming avvengono in box riservati e comunque inseriti all'interno degli ambienti di lavoro, evolvendo i caratteri delle classiche sale riunioni. Eden asseconda le modalità più veloci e dinamiche della condivisione e dell'operatività attraverso una comodità e un livello di assorbimento acustico ottimale.

EN

The work interview or brainstorming takes place in a box that is private and yet still part of the working environment, evolving the characteristics of the classic meeting room. Eden supports the fastest and most dynamic ways of sharing and operating through an excellent level of comfort and sound absorption.

FR

La réunion de travail ou le brainstorming se déroulent dans des espaces réservés mais toutefois insérés dans l'environnement de travail, faisant évoluer les caractéristiques des salles de réunion classiques. Eden soutient les modes de partage et d'activité les plus rapides et les plus dynamiques grâce au confort et à un niveau d'absorption acoustique optimal.

ES

El diálogo de trabajo o la lluvia de ideas tienen lugar en boxes reservados e incluso situados dentro de los ambientes de trabajo, lo que modifica gradualmente las características de las clásicas salas de reunión. Eden apoya las metodologías más rápidas y dinámicas del intercambio y de la operatividad a través de un confort y un nivel de absorción acústica óptimo.



IT

La presa integrata nella seduta consente una perfetta ricarica di cellulari e pc mediante connettore USB o Schuko.

EN

The power socket integrated into the seat allows a perfect recharging of mobiles and laptops by USB or Schuko plug.

FR

La prise intégrée dans le siège permet une recharge parfaite des ordinateurs et des téléphones portables via un connecteur USB ou Schuko.

ES

La toma integrada al asiento permite cargar perfectamente teléfonos móviles y ordenadores mediante un conector USB o Schuko.





IT

La telefonata o il lavoro veloce possono essere svolti comodamente con la postazione singola a piano di lavoro alto di Eden. Una dotazione tipica di spazi di attesa o di postazioni temporanee collocate all'interno di ambienti di lavoro dinamici e innovativi. Si presta perfettamente per sale conferenze come pulpito da relatore.

EN

The phone call or the quick task can be easily accommodated with the high worktop of the Eden individual workstation. A feature typical of waiting areas or temporary workstations placed within dynamic and innovative working environments. It lends itself perfectly to conference rooms as a speaker's lectern.

FR

Les appels téléphoniques ou le travail rapide peuvent être effectués confortablement grâce au poste de travail individuel avec plan de travail surélevé d'Eden. Un ensemble typique d'espaces d'attente ou de postes de travail temporaires situés dans des environnements de travail dynamiques et innovants. Il se prête parfaitement aux salles de conférence en tant que pupitre de conférence.

ES

La llamada telefónica o el trabajo rápido pueden desarrollarse cómodamente en el puesto de trabajo simple con tablero alto de Eden. Un equipamiento típico de espacios de espera o puestos temporarios colocados dentro de ambientes de trabajo dinámicos y novedosos. Se adapta perfectamente a salas de conferencia como plataforma para la persona ponente.





IT

Librerie acustiche progettate per contenere e per migliorare l'assorbimento acustico negli ambienti in cui vengono collocate. Rappresentano una soluzione tecnica e formale da inserire in ambienti fortemente riverberanti in cui si voglia modificare il suono e la sua diffusione.

EN

Acoustic bookcases designed to contain and improve sound absorption in the environments in which they are placed. They represent a technical and formal solution to insert into highly reverberant environments where you want to modify the level of sound and its diffusion.

FR

Bibliothèques acoustiques conçues pour contenir et améliorer l'absorption acoustique dans les environnements dans lesquels elles sont placées. Elles représentent une solution technique et formelle à insérer dans des environnements hautement réverbérants où l'on souhaite modifier le son et sa diffusion.

ES

Bibliotecas acústicas diseñadas para contener y mejorar la absorción acústica de los ambientes en los que se instalan. Representan una solución técnica y formal que se introducirá en ambientes muy reverberantes en los que se desea modificar el sonido y su difusión.

EDEN BOOKCASE



EDEN HB BOOKCASE



Eden

design by Paolo Pampanoni

DESCRIZIONE - description - description - descripción

IT

Eden è un sistema di imbottiti e schermi acustici.

I pannelli autoportanti proposti in due altezze, sono in pannello di legno tamburato e imbottitura in poliuretano espanso flessibile.

La struttura dei divani è in multistrati di legno e legno massello con imbottitura in poliuretano espanso, la gamba in tubolare di acciaio verniciato nero.

Diverse tipologie di piani in nobilitato per differenti funzioni: postazioni di lavoro, riunione, attesa e libreria.

EN

Eden is a system of padded and acoustic screens.

The freestanding panels are offered in a choice of two heights, in wood honeycomb panel and padded with flexible polyurethane foam.

The structure of the sofas is in multi-layered and solid wood with polyurethane foam padding, with the leg in black-painted tubular steel.

Various types of melamine tops are available for different functions: workstations, meetings, waiting areas, and bookcases

FR

Eden est un système de produits rembourrés et d'écrans acoustiques. Les panneaux autoportants proposés en deux hauteurs sont en panneau de bois alvéolaire et rembourrés de mousse polyuréthane souple.

La structure des canapés est en bois multicouche et bois massif avec rembourrage en mousse de polyuréthane, le pied en tube d'acier peint en noir.

Différents types de panneaux mélaminés pour différentes fonctions : postes de travail, salles de réunion et d'attente et bibliothèques.

ES

Eden es un sistema de acolchados y pantallas acústicas. Los tableros autoportantes propuestos en dos alturas son de panel de madera contrachapado y acolchado de poliuretano expandido flexible. La estructura de los sofás es de multicapa de madera y madera maciza con acolchado de poliuretano expandido, la pata de tubo de acero pintado negro. Varios tipos de tableros con revestimiento para diferentes funciones: puestos de trabajo, reunión, espera y biblioteca.

GARANZIA - guarantee - garantie - garantía

10 anni - 10 years - 10 ans - 10 años

METALLI - metals - métaux - metales

• nero - black - noir - negro

LEGNI - woods - bois - maderas



Nobilitato nero
Black melamine
Mélaminé noir
Nobilitado negro
(WDMBK)



Nobilitato bianco
White melamine
Mélaminé blanc
Nobilitado blanco
(WDMWH)



Nobilitato rovere naturale
Natural oak melamine
Mélaminé rouvre naturelle
Nobilitado roble natural
(WDMNO)

OPTIONAL

• **FR/** Poliuretano espanso flessibile ignifugo

• **BICOLORE/** Viene realizzato nell'ambito della stessa categoria e tipologia di tessuto

• **PRESE ELETTRICHE/**

• **FR/** Fire retardant polyurethane foam

• **TWO-COLOR/** It is made within same category and type of fabric

• **POWER SOCKETS/**

• **FR/** Mousse de polyuréthane ignifuge

• **BICOLORE/** Il est fabriqué dans la même catégorie et le même type de tissu

• **PRISES DE COURANT/**

• **FR/** Espuma de poliuretano flexible ignifuga

• **BICOLORE/** Se fabrica dentro de la misma categoría y tipo de tejido

• **TOMAS DE CORRIENTE/**

composizioni base - basic composition - compositions de base - composiciones básicas

h. 125 cm

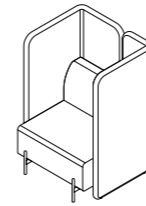

EDEN 01

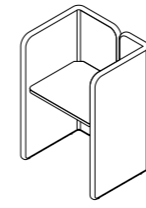

EDEN 01 DESK

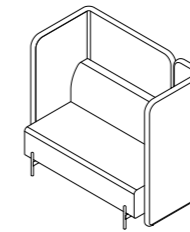

EDEN 02

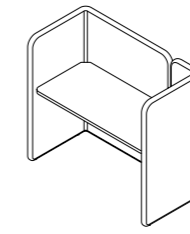

EDEN 02 DESK

h. 165 cm

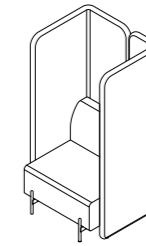

EDEN HB 01

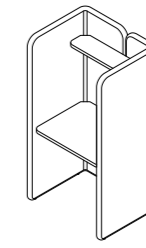

EDEN HB 01 DESK

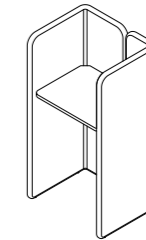

EDEN HB 01 STANDING DESK

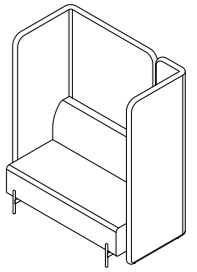

EDEN HB 02

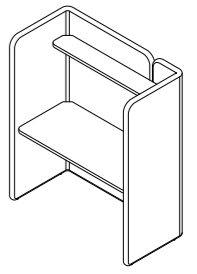

EDEN HB 02 DESK

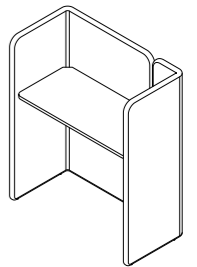

EDEN HB 02 STANDING DESK

composizioni complesse - complex composition - compositions complexes - composiciones complejas

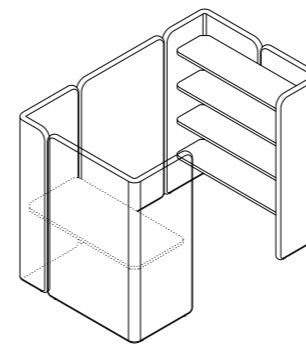

EDEN STUDIO

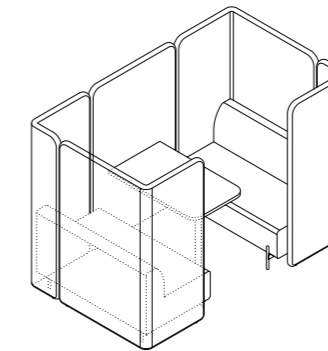

EDEN MEETING

librerie - bookcases - bibliothèque - librería

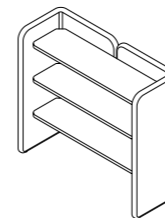

EDEN BOOKCASE

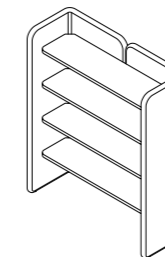

EDEN HB BOOKCASE



Eden

design by Paolo Pampanoni

Eden è un sistema di imbottiti e schermi acustici.

I pannelli autoportanti proposti in due altezze, sono in pannello di legno tamburato e imbottitura in poliuretano espanso flessibile.

La struttura dei divani è in multistrati di legno e legno massello con imbottitura in poliuretano espanso, la gamba in tubolare di acciaio verniciato nero.

Diverse tipologie di piani in nobilitato per differenti funzioni: postazioni di lavoro, riunione, attesa e libreria.

Eden is a system of padded and acoustic screens.

The freestanding panels are offered in a choice of two heights, in wood honeycomb panel and padded with flexible polyurethane foam.

The structure of the sofas is in multi-layered and solid wood with polyurethane foam padding, with the leg in black-painted tubular steel. Various types of melamine tops are available for different functions: workstations, meetings, waiting areas, and bookcases

Eden est un système de produits rembourrés et d'écrans acoustiques. Les panneaux autoportants proposés en deux hauteurs sont en panneau de bois alvéolaire et rembourrés de mousse polyuréthane souple.

La structure des canapés est en bois multicouche et bois massif avec rembourrage en mousse de polyuréthane, le pied en tube d'acier peint en noir.

Différents types de panneaux mélaminés pour différentes fonctions : postes de travail, salles de réunion et d'attente et bibliothèque.

Eden es un sistema de acolchados y pantallas acústicas. Los tableros autoportantes propuestos en dos alturas son de panel de madera contrachapado y acolchado de poliuretano expandido flexible. La estructura de los sofás es de multicapa de madera y madera maciza con acolchado de poliuretano expandido, la pata de tubo de acero pintado negro. Varios tipos de tableros con revestimiento para diferentes funciones: puestos de trabajo, reunión, espera y biblioteca.

GARANZIA - guarantee - garantie - garantía

10 anni - 10 years - 10 ans - 10 años

METALLI - metals - métaux - metales

• nero - black - noir - negro

LEGNI - woods - bois - maderas



Nobilitato nero
Black melamine
Mélaminé noir
Nobilitado negro
(WDMBK)



Nobilitato bianco
White melamine
Mélaminé blanc
Nobilitado blanco
(WDMWH)

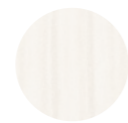

Nobilitato rovere naturale
Natural oak melamine
Mélaminé rouvre naturelle
Nobilitado roble natural
(WDMNO)

OPTIONAL

• **FR/** Poliuretano espanso flessibile ignifugo

• **BICOLORE/** Viene realizzato nell'ambito della stessa categoria e tipologia di tessuto

• **PRESE ELETTRICHE/**

• **FR/** Fire retardant polyurethane foam

• **TWO-COLOR/** It is made within same category and type of fabric

• **POWER SOCKETS/**

• **FR/** Mousse de polyuréthane ignifuge

• **BICOLORE/** Il est fabriqué dans la même catégorie et le même type de tissu

• **PRISES DE COURANT/**

• **FR/** Espuma de poliuretano flexible ignifuga

• **BICOLORE/** Se fabrica dentro de la misma categoría y tipo de tejido

• **TOMAS DE CORRIENTE/**

composizioni base - basic composition - compositions de base - composiciones básicas

h.125 cm

h.165 cm



IT

Eden un sistema, due altezze, sei funzioni.

EN

Eden
one system,
two height,
six functions.

FR

Eden
un système,
deux hauteurs,
six fonctions.

ES

Eden
un sistema,
dos alturas,
seis funciones.

EDEN HB 02

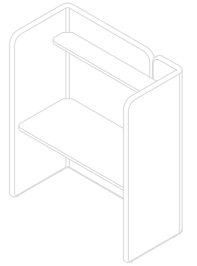

EDEN HB 02 DESK

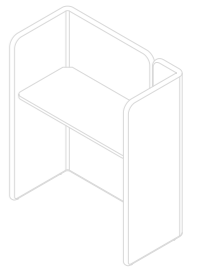

EDEN HB 02 STANDING DESK



Eden

design by Paolo Pampanoni

Eden è un sistema di imbottiti e schermi acustici. I pannelli autoportanti proposti in due altezze, sono in pannello di legno tamburato e imbottitura in poliuretano espanso flessibile. La struttura dei divani è in multistrato di legno e legno massello con imbottitura in poliuretano espanso, la gamba in tubolare di acciaio verniciato nero. Diverse tipologie di piani in nobilitato per differenti funzioni: postazioni di lavoro, riunione, attesa e libreria.

GARANZIA - guarantee -

10 anni - 10 years - 10 ans - 10 años

METALLI - metals - méta

• nero - black - noir - negro

LEGNI - woods - bois - m

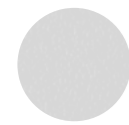

Nobilitato nero
Black melamine
Mélaminé noir
Nobilitado negro
(WDMBK)

OPTIONAL

- **FR/** Poliuretano espanso flessibile ignifugo
- **BICOLORE/** Viene realizzato nell'ambito della stessa categoria e tipologia di tessuto
- **PRESE ELETTRICHE/**



composizioni base - basic composition - compositions de base - composiciones básicas

h. 125 cm

h. 165 cm

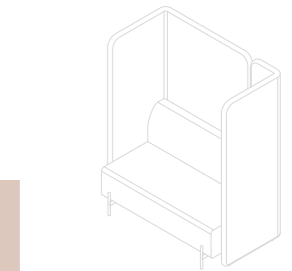
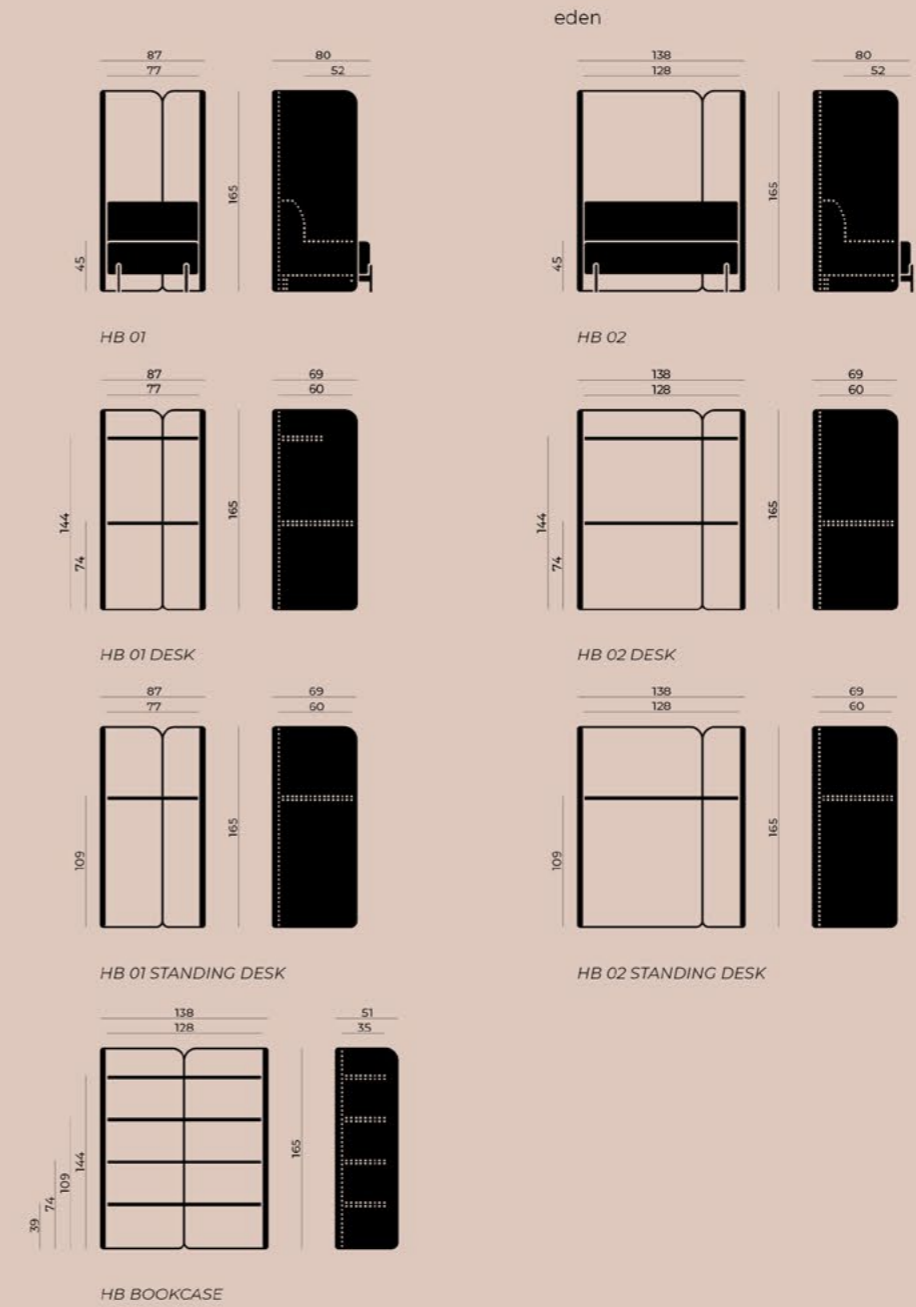
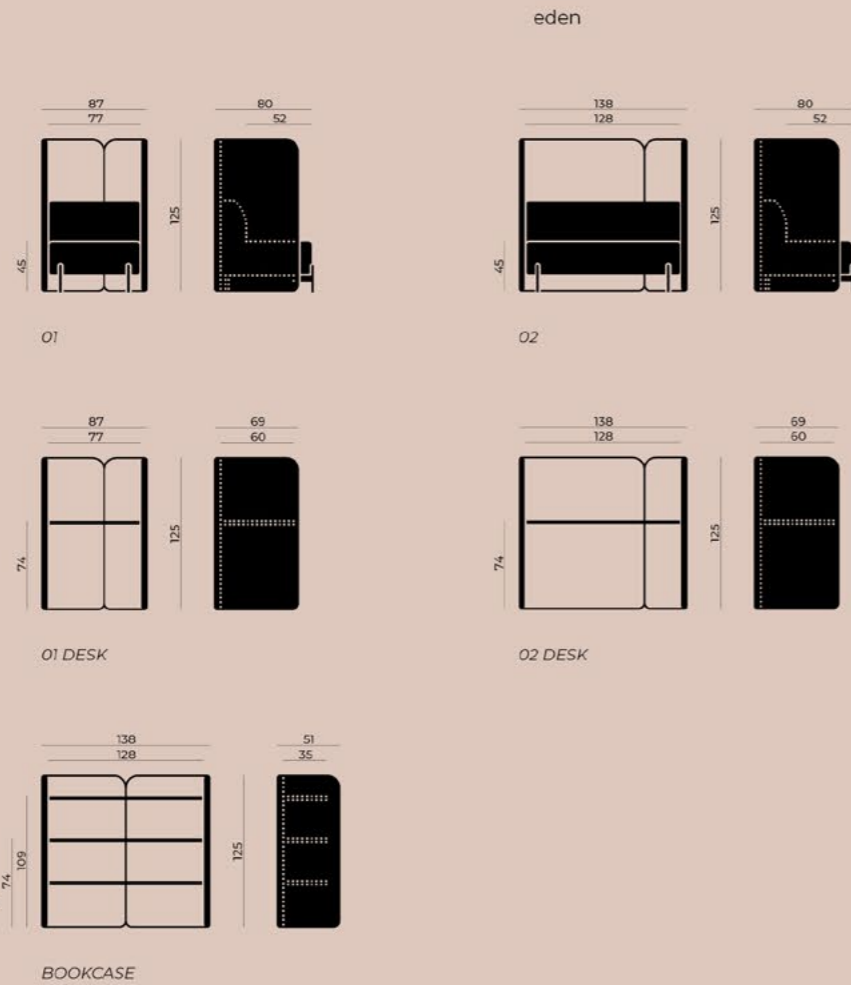

EDEN HB O2

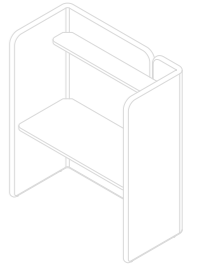

EDEN HB O2 DESK

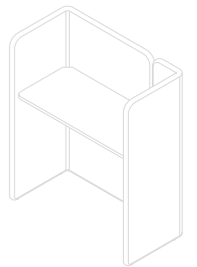

EDEN HB O2 STANDING DESK

Eden

design by Paolo Pampanoni

Eden è un sistema di imbottiti e schermi acustici.

I pannelli autoportanti proposti in due altezze, sono in pannello di legno tamburato e imbottitura in poliuretano espanso flessibile.

La struttura dei divani è in multistrato di legno e legno massello con imbottitura in poliuretano espanso, la gamba in tubolare di acciaio verniciato nero.

Diverse tipologie di piani in nobilitato per differenti funzioni: postazioni di lavoro, riunione, attesa e libreria.

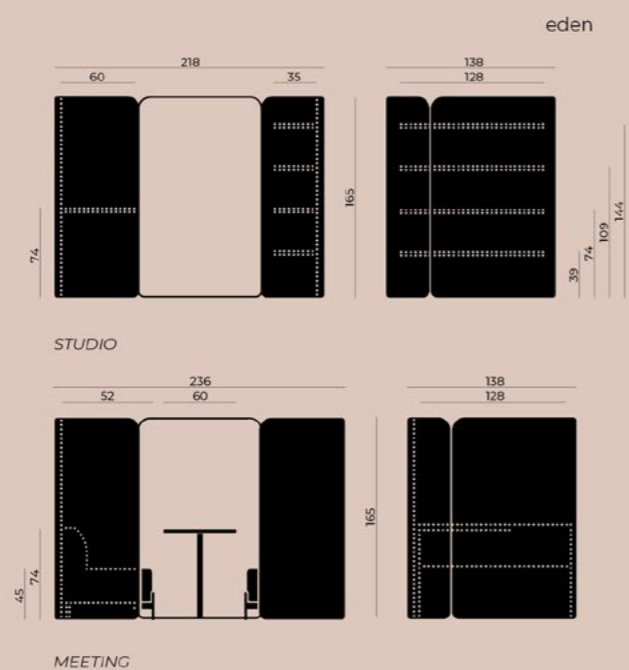

GARANZIA - guarantee - garantía

10 anni - 10 years - 10 ans - 10 años

METALLI - metals - métaux

• nero - black - noir - negro

LEGNI - woods - bois - maderas

• Nobilitato nero
• Black melamine
• Mélangé noir
• Nobilitado negro
(WDMBK)

OPTIONAL

- **FR/** Poliuretano espanso flessibile ignifugo
- **BICOLORE/** Viene realizzato nell'ambito della stessa categoria e tipologia di tessuto
- **PRESE ELETTRICHE/**



composizioni base - basic composition - compositions de base - composiciones básicas

h. 125 cm



EDEN 01



EDEN 01 DESK



EDEN 02



EDEN 02 DESK

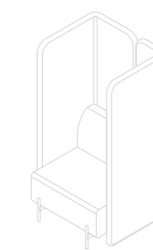

EDEN HB 01

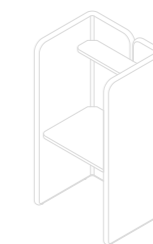

EDEN HB 01 DESK

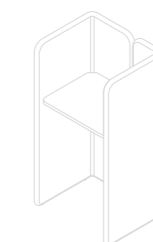

EDEN HB 01 STANDING DESK

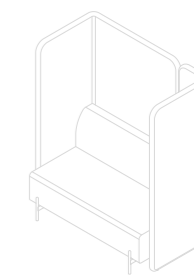

EDEN HB 02

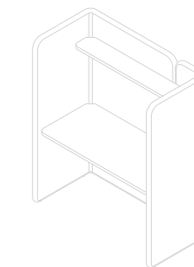

EDEN HB 02 DESK

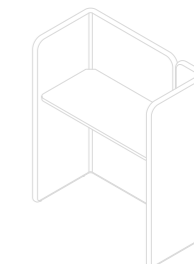

EDEN HB 02 STANDING DESK

composizioni complesse - complex composition - compositions complexes - composiciones complejas

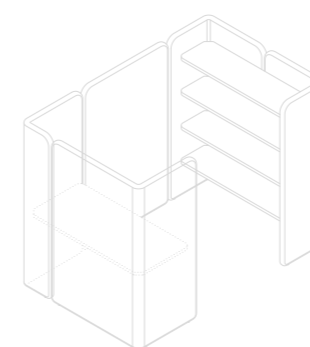

EDEN STUDIO

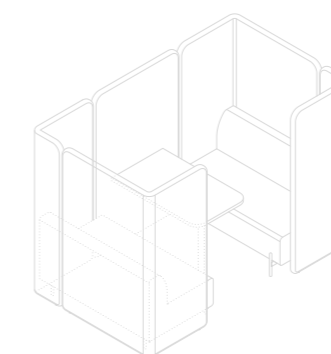

EDEN MEETING

librerie - bookcases - bibliothèque - librería



EDEN BOOKCASE



EDEN HB BOOKCASE

Mirage - Cat. C

100% Poliestere Fr - Trevira CS®
 100% Polyester Fr - Trevira CS®
 100% Polyester Fr - Trevira CS®
 100% Poliéster Fr - Trevira CS®

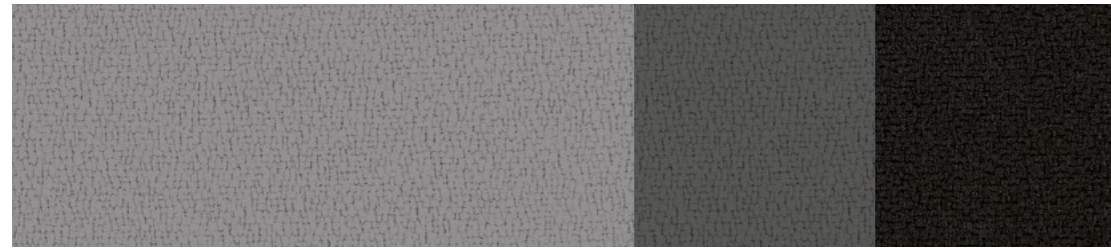

MG04
Grigio chiaro
 Light grey
 Gris clair
 Gris claro

MG24
Grigio
 Grey
 Gris
 Gris

MG01
Nero
 Black
 Noir
 Negro

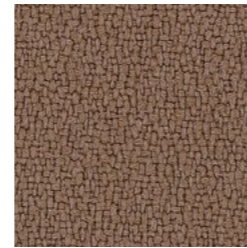

MG06
Marrone
 Brown
 Brun
 Marrón

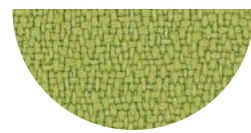

MG25
Verde chiaro
 Light green
 Vert clair
 Verde claro



MG05
Verde
 Green
 Vert
 Verde

MG03
Blu
 Blue
 Bleu
 Azul

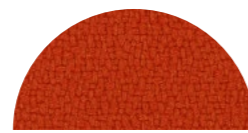

MG07
Arancio
 Orange
 Orange
 Naranja



MG09
Beige
 Beige
 Beige
 Beige



MG33
Azzurro
 Light blue
 Bleu ciel
 Azul

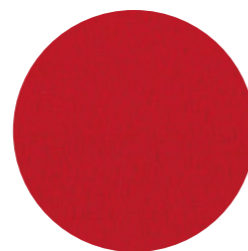

MG02
Rosso
 Red
 Rouge
 Rojo

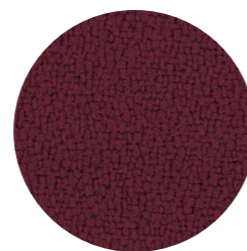

MG32
Bordeaux
 Bordeaux
 Bordeaux
 Bordeaux

Chili - Cat. C

100% Poliestere riciclato post-consumo Fr
 100% Post consumer recycled polyester Fr
 100% Polyester recyclé post-consommation Fr
 100% Poliéster reciclado posconsumo Fr



CL04
Grigio
 Grey
 Gris
 Gris

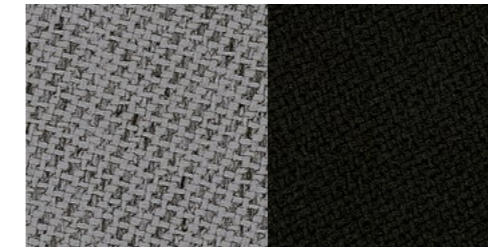

CL24
Grigio scuro
 Dark grey
 Gris foncé
 Gris oscuro

CL01
Nero
 Black
 Noir
 Negro

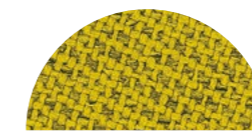

CL08
Ocra
 Ocher
 Ocre
 Ocre

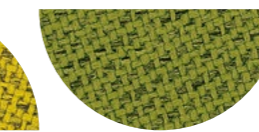

CL25
Verde
 Green
 Vert
 Verde

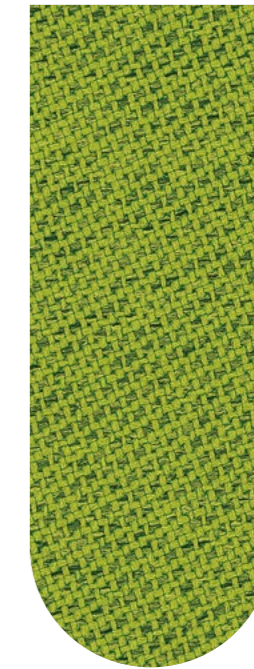

CL05
Verde chiaro
 Light green
 Vert clair
 Verde claro



CL06
Marrone
 Brown
 Brun
 Marrón



CL26
Marrone scuro
 Dark brown
 Brun foncé
 Marrón oscuro



CL32
Amaranto
 Amaranth
 Amarante
 Amaranto

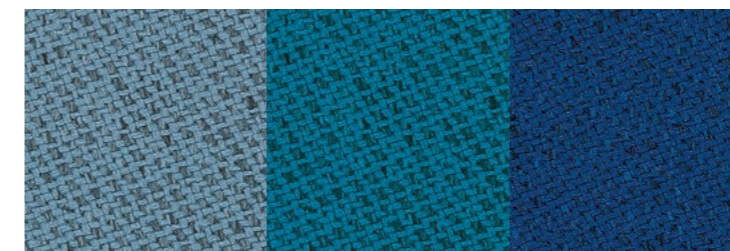

CL33
Azzurro
 Light blue
 Bleu ciel
 Azul

CL23
Turchese
 Turquoise
 Turquoise
 Turquesa

CL03
Blu
 Blue
 Bleu
 Azul

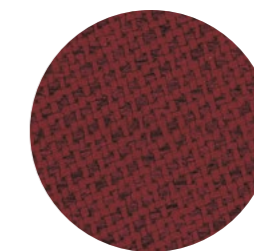

CL22
Bordeaux
 Bordeaux
 Bordeaux
 Bordeaux

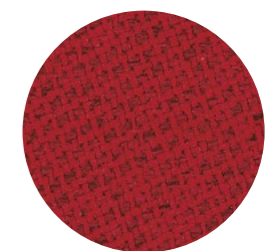

CL02
Rosso
 Red
 Rouge
 Rojo

Step Melange - Cat. E

100% Poliestere Fr - Trevira CS®
 100% Polyester Fr - Trevira CS®
 100% Polyester Fr - Trevira CS®
 100% Poliéster Fr - Trevira CS®



ST04

Grigio
 Grey
 Gris
 Gris

ST24

Grigio scuro
 Dark grey
 Gris foncé
 Gris oscuro

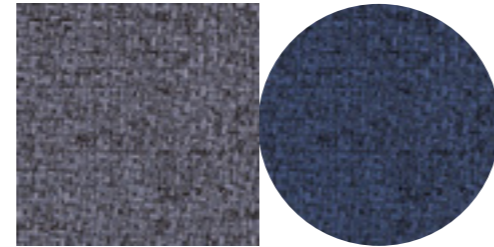

ST03

Blu
 Blue
 Bleu
 Azul

ST33

Blu scuro
 Dark blue
 Bleu foncé
 Azul oscuro



ST09

Tortora
 Grey beige
 Beige gris
 Taupe



ST06

Marrone
 Brown
 Brun
 Marrón



ST19

Beige
 Beige
 Beige
 Beige

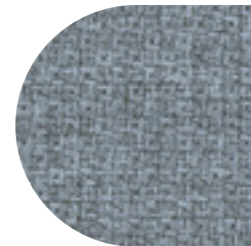

ST23

Turchese
 Turquoise
 Turquoise
 Azul turquesa

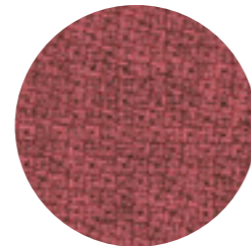

ST10

Salmone
 Salmon
 Saumoné
 Salmón

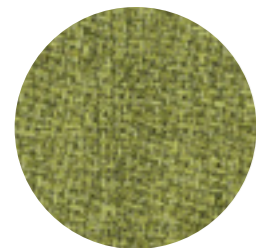

ST25

Verde chiaro
 Light green
 Vert clair
 Verde claro



ST05

Verde
 Green
 Vert
 Verde

ST35

Verde scuro
 Dark green
 Vert foncé
 Verde oscuro

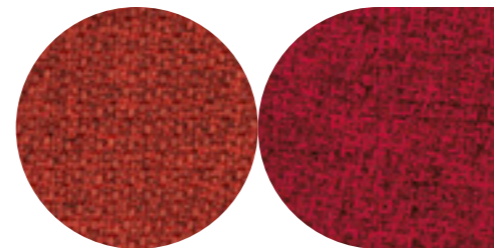

ST07

Arancione
 Orange
 Orange
 Naranja

ST02

Rosso
 Red
 Rouge
 Rojo

Fenice - Cat. E

75% Lana - 25% Poliammide
 75% Wool - 25% Polyamide
 75% Laine - 25% Polyamide
 75% Lana - 25% Poliamida

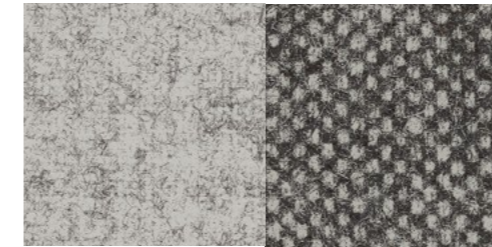

FE04

Grigio
 Grey
 Gris
 Gris

FS24

Grigio scuro
 Dark grey
 Gris foncé
 Grigio scuro

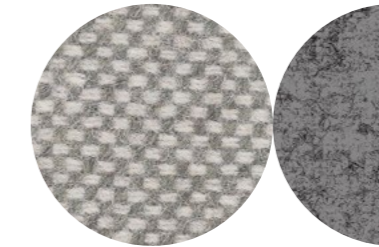

FS04

Grigio
 Grey
 Gris
 Gris

FE24

Grigio scuro
 Dark grey
 Gris foncé
 Gris oscuro

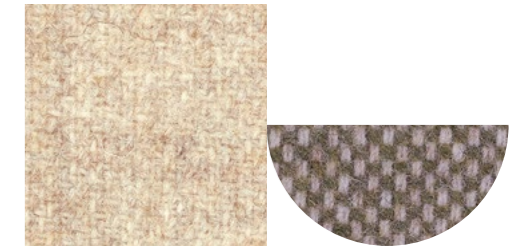

FE09

Beige
 Beige
 Beige
 Beige

FS06

Marrone
 Brown
 Brun
 Marrón



FE35

Verde scuro
 Dark green
 Vert foncé
 Verde oscuro

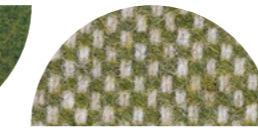

FS05

Verde
 Green
 Vert
 Verde

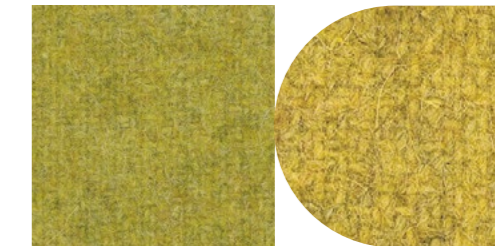

FE05

Verde
 Green
 Vert
 Verde

FE25

Verde chiaro
 Light green
 Vert clair
 Verde claro

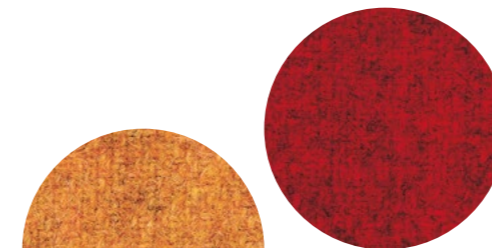

FE07

Arancio
 Orange
 Orange
 Naranja

FE22

Rosso
 Red
 Rouge
 Rojo

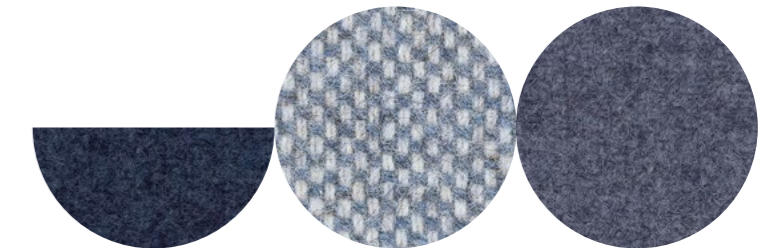

FE03

Blu scuro
 Dark blue
 Bleu foncé
 Azul oscuro

FS03

Blu
 Blue
 Bleu
 Azul

FE33

Blu
 Blue
 Bleu
 Azul

Nabucco - Cat. F

100% Poliestere Fr - Trevira CS®
 100% Polyester Fr - Trevira CS®
 100% Polyester Fr - Trevira CS®
 100% Poliéster Fr - Trevira CS®

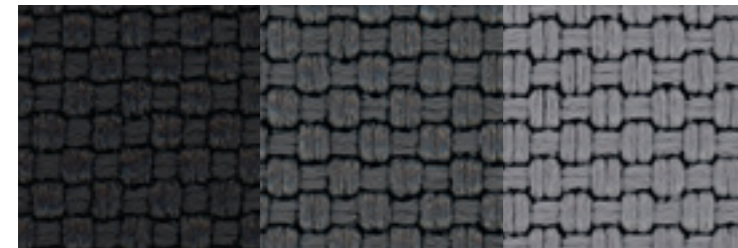

NA01
Antracite
 Anthracite
 Anthracite
 Antracita

NA24
Grigio scuro
 Dark grey
 Gris foncé
 Gris oscuro

NA04
Grigio chiaro
 Light grey
 Gris clair
 Gris claro

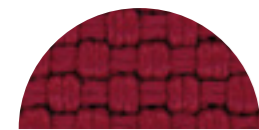

NA02
Rosso
 Red
 Rouge
 Rojo

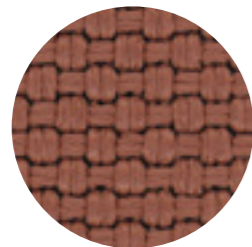

NA22
Salmon
 Salmon
 Saumoné
 Salmón

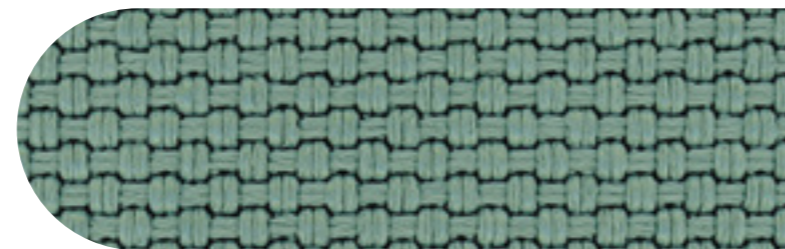

NA05
Verde chiaro
 Light green
 Vert clair
 Verde claro

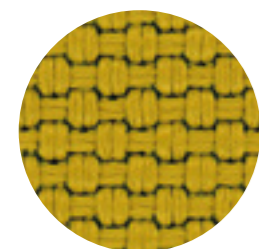

NA08
Ocra
 Ocher
 Ocre
 Ocre

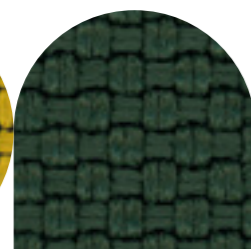

NA25
Verde scuro
 Dark green
 Vert foncé
 Verde oscuro

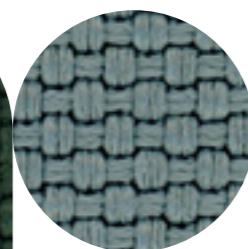

NA33
Azzurro
 Light blue
 Bleu ciel
 Azul

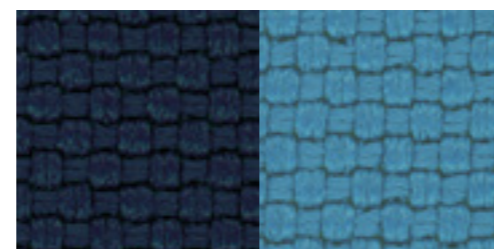

NA03
Blu scuro
 Dark blue
 Bleu foncé
 Azul oscuro

NA23
Turchese
 Turquoise
 Turquoise
 Azul turquesa

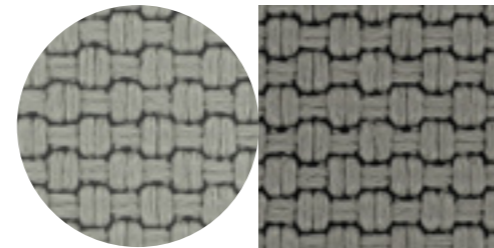

NA09
Tortora
 Grey beige
 Beige gris
 Taupe

NA06
Beige
 Beige
 Beige
 Beige

Morph - Cat. G

85% Lana della Nuova Zelanda - 15% Poliammide
 85% Wools of New Zealand - 15% Polyamide
 85% Laine de Nouvelle Zélande - 15% Polyamide
 85% Lana de Nueva Zelanda - 15% Poliamida

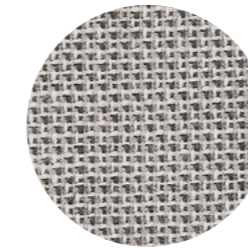

MO04
Grigio
 Grey
 Gris
 Gris

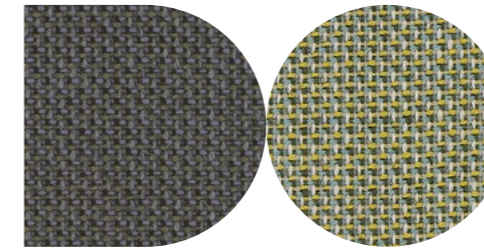

MO24
Antracite
 Anthracite
 Anthracite
 Antracita

MO25
Verde oliva
 Olive green
 Vert olive
 Verde oliva

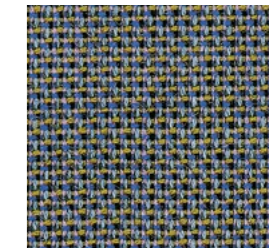

MO03
Blu
 Blue
 Bleu
 Azul



MO09
Beige
 Beige
 Beige
 Beige



MO06
Nocciola
 Hazel
 Noisette
 Avellana

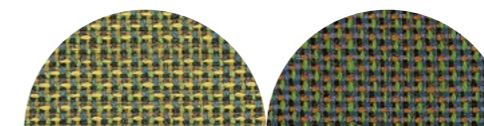

MO05
Verde
 Green
 Vert
 Verde

MO35
Verde scuro
 Dark green
 Vert foncé
 Verde oscuro



MO23
Blu scuro
 Dark blue
 Bleu foncé
 Azul oscuro

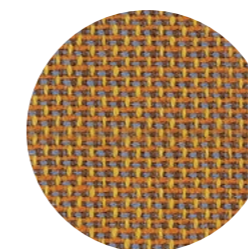

MO08
Giallo
 Yellow
 Jaune
 Amarillo



MO07
Arancio
 Orange
 Orange
 Naranja

MO02
Rosso
 Red
 Rouge
 Rojo

Gorgeous - Cat. G

100% PES Fr
100% PES Fr
100% PES Fr
100% PES Fr



GG04
Grigio
Grey
Gris
Gris

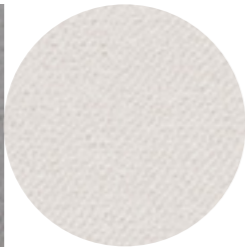

GG24
Grigio chiaro
Light grey
Gris clair
Gris claro



GG09
Beige
Beige
Beige
Beige



GG26
Tortora
Grey beige
Beige gris
Taupe



GG01
Nero
Black
Noir
Negro

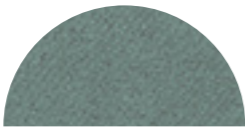

GG05
Verde
Green
Vert
Verde



GG06
Marrone
Brown
Brun
Marrón



GG03
Azzurro
Light blue
Bleu ciel
Azul



GG25
Turchese
Turquoise
Turquoise
Azul turquesa

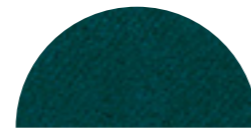

GG35
Petrolio
Petrol
Pétrole
Petróleo



GG23
Blu
Blue
Bleu
Azul



GG22
Amaranto
Amaranth
Amarante
Amaranto



GG20
Petunia
Petunia
Pétunia
Petunia



GG10
Rosa antico
Antique rose
Rose antique
Rosa palo

Legni/Woods/Bois/Maderas



WDMBK
Nobilitato nero
Black melamine
Mélaminé noir
Nobilitado negro

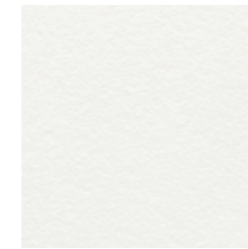

WDMWH
Nobilitato bianco
White melamine
Mélaminé blanc
Nobilitado blanco



WDMNO
Nobilitato rovere naturale
Natural oak melamine
Mélaminé rouvre naturelle
Nobilitado roble natural

nahu®

Diritti riservati.
La riproduzione anche parziale è consentita solo previa autorizzazione scritta di Linea Fabbrica Srl

All rights reserved.
No parts of this catalogue may be reproduced without permission in writing form by Linea Fabbrica Srl

Tous droits réservés.
Toute reproduction totale ou partielle est interdite, sans autorisation écrite préalable de Linea Fabbrica Srl

Reservados todos los derechos.
La reproducción, total o parcial, está permitida solo con la autorización por escrito de Linea Fabbrica Srl

A.D./
Arch. Paolo Pampanoni

Concept and Graphic/
d+a

Photos/
Studiolux
Officine Fotografiche Friulane
Aztec SNC

Stylist/
Tiziana De Mario
Rosanna Bugnicolo
Morena Chiodi

Printing/
Tipolito Properzio

Binding/
Legatoria Umbra

Thanks to/
Binova Interni
Cumini Interiors

E.D./
Mar. 2022



Linea Fabbrica Srl
company certified

UNI EN ISO 9001:2015/
Certificate nr. 50 100 14238
Rev.001

UNI EN ISO 14001:2015/
Certificate nr. 50 100 14243
Rev. 001

UNI EN ISO 45001:2018/
Certificate nr. 50 100 14970
Rev. 001



The mark of
responsible forestry

Linea Fabbrica srl
company certified FSC®

Via Thonet, 5
33044 Manzano (UD)
Tel: +39. 0432 747111
Fax: +39. 0432 747199
info@nahu.it
www.nahu.it

nahu